



领先的中国色彩与光泽分析专家
China's leading expert of color and gloss analysis



台式透射分光测色仪 产品使用说明 ▶

CS-810

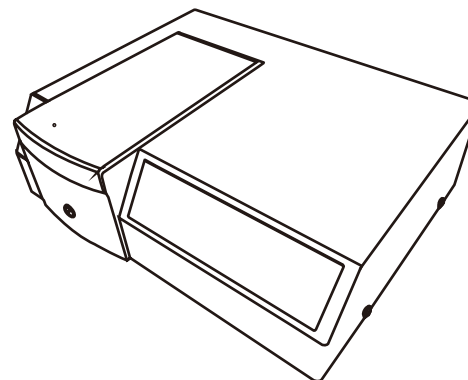

杭州彩谱科技有限公司
HANGZHOU CHNSPEC TECHNOLOGY CO.,LTD

地址：杭州市江干区文渊北路166号华银教育大厦7楼

全国免费电话：4007-7272-81

传真：0571-85888727

CATALOGUE 目录

[一]透射分光测色仪使用须知-----	01
[二]透射分光测色仪注意事项-----	01
[三]透射分光测色仪技术参数-----	02
[四]外观结构介绍 -----	02
[五]仪器安装 -----	03
[六]驱动安装 -----	05
[七]仪器使用 -----	06
[八]测试 -----	09
[九]校准 -----	11
[十]系统配置图-----	13
[十一]异常处理 -----	14
[十二]测量结果分析 -----	14
[十三]公司声明 -----	14

透射分光测色仪使用须知

- 1、透射分光测色仪是基于分光技术平台的测色仪，主要用于测量样品的光谱数据、光谱图、色度值、色差值、呈现合格/不合格、色彩仿真示意图等。结构紧凑轻便、测试高度精准、操作简易。
- 2、透射分光测色仪广泛应用于实验室、工厂、或现场操作，足以在几乎所有应用领域的质量控制中实现优秀的色彩测量。
- 3、限制性保修的时间段是自购买本仪器开始起（时间：如一年）的时间。如果您的仪器需要服务，请将仪器带到当地的销售部或通过网址：www.hzcaipu.com 联系我们来进行维修。
- 4、为了避免仪器精度受影响，请不要将仪器私自拆开。如果由于私自拆卸机器或不正确的使用而导致仪器损坏，请用户自行负责。

注意事项

- 1、本机属精密仪器,不能承受因跌落而导致的碰撞,使用时请放置于相对平整的地方
- 2、本机不能防潮或抗潮,受潮或液体溅入易损坏本机。
- 3、本机的屏幕是由玻璃制成,受到异常外力或锐器的作用易损坏。
- 4、本公司建议使用原配电源适配器。
- 5、为保障本机正常工作,请不要在过冷或过热的地方存放和使用,也勿将本机放置在潮湿或阳光长期直射的地方,更不要在强震等恶劣的环境中使用本机,以免发生意外。
- 6、本机是精密仪器,使用时请避开强电磁干扰。
- 7、为保证测量准确,请不要用本机测量不平整的表面。
- 8、为保证测量准确,测试时请保持仪器平稳,不要摇晃。
- 9、测试时请将仪器的测试口紧贴测试物体表面,但不要用力按压。
- 10、本机属精密仪器,使用完毕请将仪器装入包装箱内保管。
- 11、请将仪器存放在干燥的地方。
- 12、本机及说明书如有进一步改进或补充,恕不另行通知。如有疑问,敬请垂询本公司。

技术参数

测量条件	d/0(散射光源, 0度观测角) (符合CIE NO.15、ISO 7724/1、ASTM E1164、DIN 5033 Teil17、JIS Z8722、Condition c标准。)
积分球	Φ40mm,Avian-D全漫反射表面涂层
照明光源	CLEDs(全波段均衡Led光源)
感应器	双光路阵列传感器
波长范围	400nm-700nm
波长间隔	10nm
半带宽	5nm
测量范围	0-200%
分辨率	0.0001
观察者角度	2°/10°
观测光源	A,C,D50,D55,D65,D75,F1,F2,F3,F4,F5,F6,F7,F8,F9,F10,F11,F12,CWF,U30,DLF,NBF,TL83,TL84
显示	透射图/数据, 样品色度值, 色差值/图, 合格/不合格结果, 颜色偏向, 颜色仿真, 历史数据色彩仿真, 标准样手动输入, 检测报告
测量间隔	1秒
测量时间	1秒
测量孔径	直径10mm
颜色空间	CIE Lab,LCh,CIE Luv,XYZ,Yxy, 透射率,Hunter Lab,Musell,MI,CMYK
色差公式	$\Delta E^*ab, \Delta E^*CH, \Delta E^*uv, \Delta E^*cmc(2:1), \Delta E^*cmc(1:1), \Delta E^*94, \Delta E^*00$
其他指标	WI(ASTM E313-00,ASTM E313-73, CIE/ISO, Hunter, Taube Berger Stensby), YI(ASTM D1925, ASTM E313-00, ASTM E313-73), Tint(ASTM E313,CIE,Ganz) 同色异谱指数Milmm, 沾色牢度, 变色牢度, APHA, Hazen, Pt-Co(铂钴指数), Gardner(加德纳指数), Saybolt(赛伯特指数), Astm color
重复性	分光透射率: 标准偏差在0.08%以内, 色度值: ΔE^*ab 0.015 (校正后, 以间隔5s测量白板30次标准偏差), 最大值0.03
台间差	ΔE^*ab 0.2以内 (对12块BCRA陶瓷标准色板测量结果的最大值)
数据接口	USB
存储数据	海量存储(PC)
光源寿命	5年150万次
尺寸	475*340*150mm(L*W*H)
重量	约7kg
操作温度	0-45°C, 相对湿度80%或更低(在35°C下), 无水气凝结
存储温度	-25°C到55°C, 相对湿度80%或更低(在35°C下), 无水气凝结
标准附件	电源线、颜色管理软件、驱动软件、数据线、黑校正板、40*10mm、比色皿
可选附件	40*33mm比色皿(测量ASTM Color), 40*100mm比色皿(测量Saybolt)

外观结构介绍



主机正面

- ① 样品室：用于放置参比样品和待测样品
- ② 样品架拉杆：推拉拉杆可以变换样品架拉杆
- ③ 仪器铭牌：揭示正版商标



主机背面

- ① 电源插座:仪器电源线插座
- ② 电源开关:仪器的电源开关
- ③ usb输出:连接计算机

仪器安装

一：仪器安装环境

- 1：仪器的额定电压为220V,50Hz。供电电压不正常会使仪器无法正常工作。
- 2：仪器应安装在干燥的室内。
- 3：仪器应安装在坚固的工作平台上，且无强烈的震动。
- 4：仪器应远离电场，高强度的磁场及会产生高强度波的设备。
- 5：仪器应避免强光的直接照射。
- 6：仪器供电电源应有接地线保护。

二：仪器安装

- 1：开箱后检查仪器是否有损坏，并跟据装箱单核对附件是否齐全。
- 2：确认配件无误后，取出仪器单元模块。
- 3：检查仪器是否工作正常。

驱动安装

- 1:打开驱动文件夹Driver，如果你的PC是64位的，双击VCP_V1.3.1_Setup_x64.exe。如图



2:等待下一步安装。

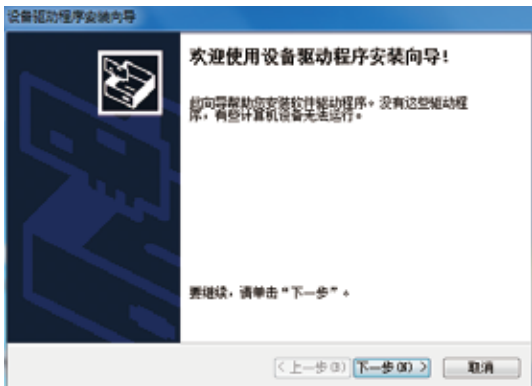

3: 完成后驱动就安装成功了。



4: 如果你的电脑是32位的，双击dpinst_x86.exe。依次按之前的步骤安装即可。

仪器使用

步骤1: 仪器在使用时，应先预热30分钟。

步骤2: 接上交流220V电源插头,如图所示:



步骤3: 按下开机键一。

步骤4: 黑校准: 拉开样品盖室, 将遮光体放入样品架, 合上样品室盖, 进行校准。

步骤5: 白校准: 将无色样品(蒸馏水)放入样品架。并推拉样品架使其进入光路, 合上样品盖进行校准。

步骤6: 打开软件, 仪器测试样品时, 应先测试标样, 之后在测试试样。

步骤7: 在软件中点击菜单栏中的设置——列表选项, 设置光谱, 颜色空间, 指数等。

如下图所示:

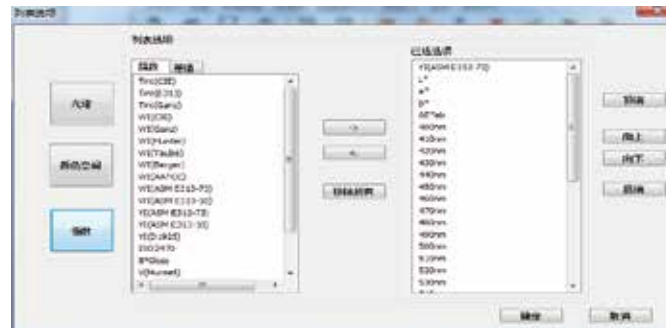

如需要调到左边去，如图所示：



序号	名称	测试模式	400nm	ΔE^*ab	410nm	4

序号	名称	测试模式	ΔE^*ab	400nm	410nm	420nm

可以将设置——列表选项中的该参数选中，然后点击向上或顶端即可。

测试

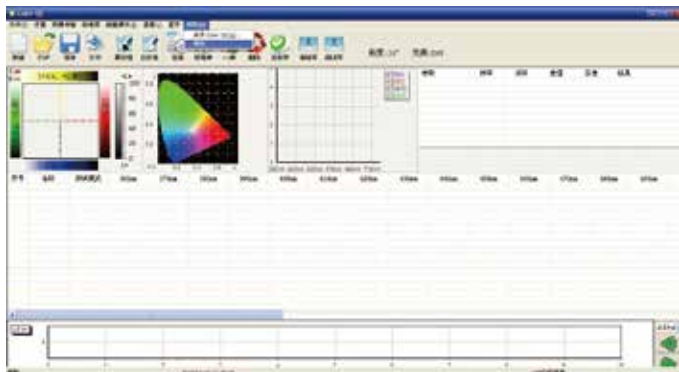

打开颜色管理软件，点击菜单栏“帮助”，下拉菜单中点选帮助即弹出颜色分析软件的使用说明窗口，如下图所示。

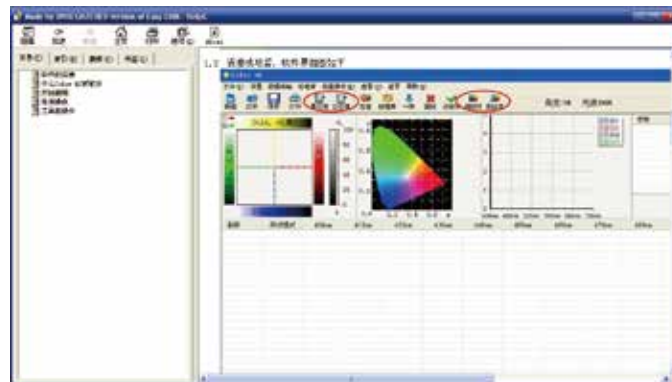

当仪器和电脑连接成功时，黑白校准和测标样、测试样工具呈现可选状态。

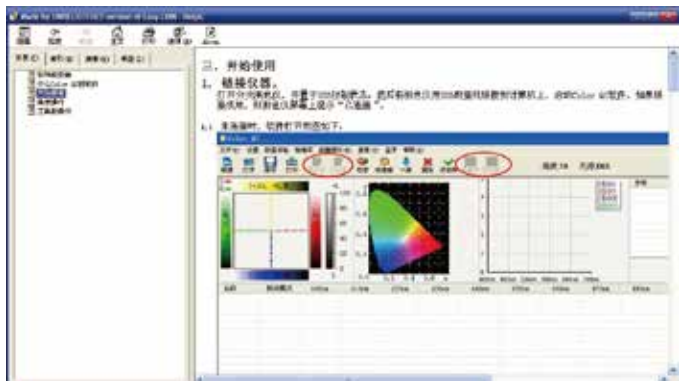

点击左边栏开始使用模块可看到软件的使用方法，仪器未连接到电脑时，黑白校准和测标样、测试样工具呈现无法选择状态。



当仪器和电脑连接成功时，将黑校正板放置于测试架，并盖上测试室盖子，点击工具栏“黑校准”按钮，对仪器进行校准。

校准



黑校准完成后,取下黑校正板,点击窗口弹出框的白校准按钮进行白校准。

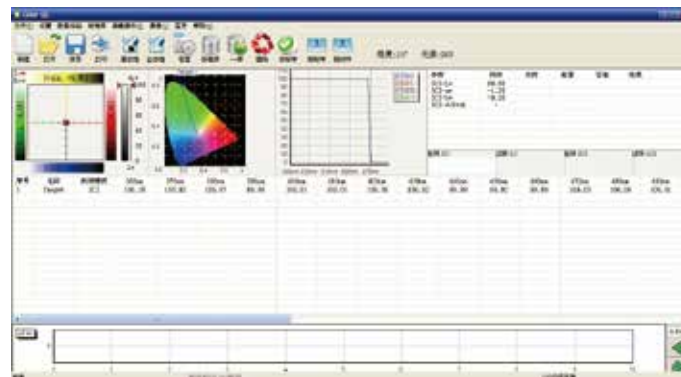

白校准完成后,将样品放入测试架,如上图。点击测标样进行标样测试,如下图。

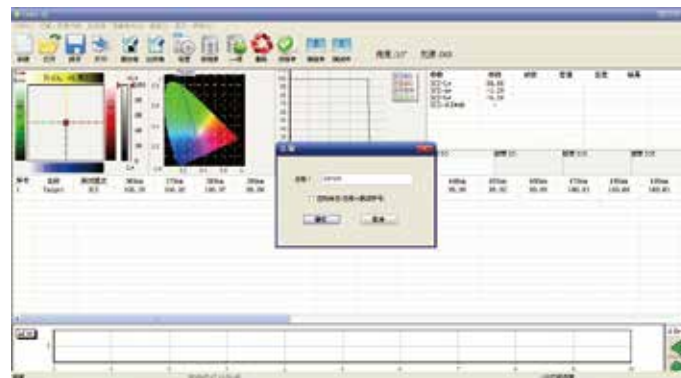

标样测试完后可保存标样并对标样进行命名,如上图。

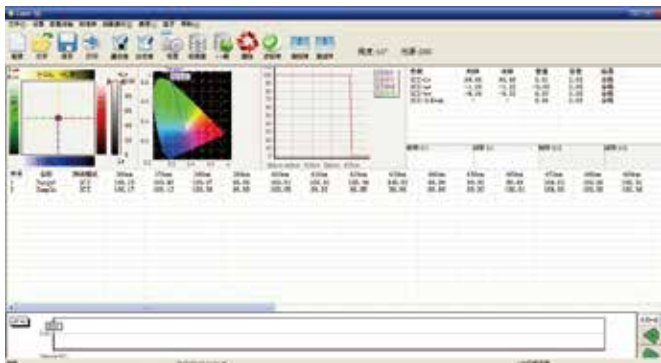

标样测试完后取出标样，将试样放入测试架，并点击颜色管理软件中的测试样进行测试，得出试样的测试数据，可进行对比，并且可将测试数据进行打印输出。

系统配置图

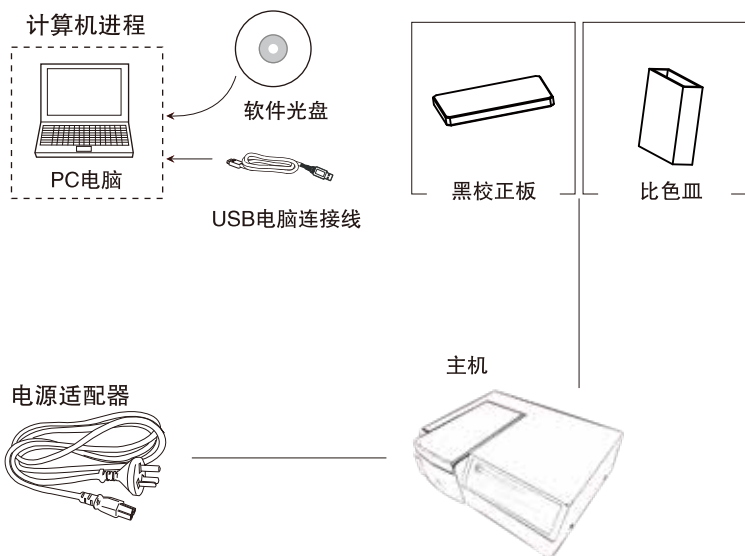

异常处理

异常情况	分析	处理方法
1、仪器无法开机	1、检查仪器是否连接到外部直流电源适配器 检查容差设置是否合理	1、插入直流电源，重新调整容差设置
2、测量结果报错	2、检查测量时仪器及测试品是否平稳，测量口与测量面接触是否紧密良好	2、保持仪器及测试品平稳
3、测试数值异常	3、检查测量部位是否是混色	3、测量单一颜色部分，不要测量混色

测量结果分析

▼ ΔE 总色差的大小 $\Delta E^*_{ab} = \sqrt{(\Delta L^*)^2 + (\Delta a^*)^2 + (\Delta b^*)^2}$

$\Delta L+$ 值表示偏白， $\Delta L-$ 值表示偏黑； $\Delta a+$ 值表示偏红， $\Delta a-$ 值表示偏绿； $\Delta b+$ 表示偏黄， $\Delta b-$ 值表示偏蓝。当一种颜色用CIE*a*b*表示时，L*表示明度值；a*表示红/绿值及b*表示黄/蓝值。

▼ CIE LAB

CIE LAB色空间是基于一种颜色不能同时既是绿又是红、也不能同时既是蓝又是黄这个理论而建立。所以，单一数值可用于描述红/绿色及黄/蓝色特征。当一种颜色用CIE L*a*b*表示时，L*表示明度值；a*表示红/绿值及b*表示黄/蓝值。

▼ CIE LCH

CIE LCH颜色模型采用了同L*a*b*一样的颜色空间，但它采用L*表示明度值；C*表示饱和度和值及h表示色调角度的柱形坐标。

公司声明

- 本公司向用户承诺，我们生产的测色仪系列产品，保修期限为购买之日起的三年内有效，正常使用情况下非人为造成的故障问题，本公司将负责给予免费维修，超过保修期或人为因素导致的故障，本公司将提供维护，将收取维修材料及相关费用。（详细保修参看彩谱保修细则）
- 本公司对于第三者因使用本产品引起的任何损失或索赔不负任何责任。
- 本公司对于由于因故障、维修或断电造成的数据丢失而导致的任何损害或损失均不负任何责任。为防止重要数据的丢失，请务必对所有重要数据进行备份。
- 本产品中预置的所有作品之版权归彩谱公司所有，受《中华人民共和国著作权法》保护。
- 我公司出售本产品的行为不代表向用户转让或授予与作品版权相关的任何权利。
- 本说明书所提到的产品规格及信息仅供参考，内容亦会随时更新，恕不另行通知，最新版本可到 www.hzcaipu.com 查询。



China's leading expert of color
and gloss analysis



SERIES OF SPECTROPHOTOMETER OPERATION MANUAL ▶ CS-810

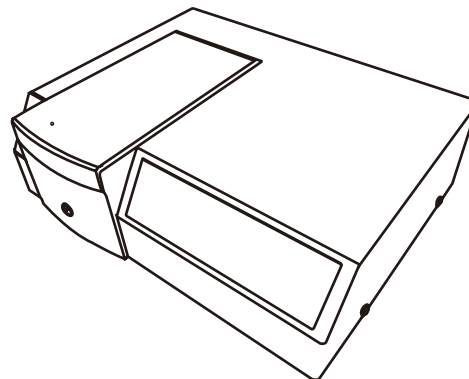

Service hotline:+86 571 85888707

Address:No.166 of Wenyuan Road,Jiangan District,Hangzhou City,China



Please do not disassemble the product without the assistance of customer support center. If you have any questions, please contact the local agency.

www.chnspec.com

CATALOGUE

[I] Terms of use	01
[II] Notes	01
[III] Technical Specifications	02
[IV] Appearance and structure	03
[V] Instrument installation	04
[VI] Driver Installation	04
[VII] Instrument Operation	06
[VIII] Testing	09
[IX] Calibration	10
[X] System deployment diagram	13
[XI] Trouble Shooting	14
[XII] Testing Result Analysis	14
[XIII] Company's statement	15

Terms of use

1. Our spectrophotometer is the first model in China that adopts spectrum splitting technology. It is mainly used to measure the sample spectral value, color value, color difference value, etc. It is a bench-top model with compact structure which makes it easy to carry out, accurate and high precise.
2. Our spectrophotometer is widely used in factories, labs and on spot. It can achieve great color measurement result in the quality control of almost all fields.
3. The warranty period starts from date you purchase the spectrophotometer. If you need warranty service, please contact local agency or visit our website www.chnspec.com to contact us.
4. To avoid damage to instrument accuracy or precision, please do not disassemble the instrument. Damage to the instrument caused by disassembly or improper use is NOT included in the warranty.

Notes

1. Carefully put the instrument on a flat surface.
2. This instrument is not moisture proof, moisture may damage the instrument.
3. Large force, or sharp objects may damage the screen.
4. It is recommended to use the original power adapter with the instrument.
5. To ensure that the instrument works properly, please do not store, or use the instrument in places that are too hot or too cold; please do not put the machine in damp locations, or directly under sunlight. Do not use the instrument in severe environment such as strong shock or quake.
6. Check battery before usage.
7. Please avoid strong electromagnetic interference in usage.
8. Please do not use the instrument to measure surfaces that are not flat.
9. Please keep the instrument steady; do not shake the instrument in usage.
10. Please put the instrument directly on the spot to be measured, but do not apply strong force.
11. Please store the instrument in a dry area. If it is not used in a long time, please take the battery out.
12. If this user manual is further updated, we are not obliged to notify you. If you have further questions, please ask on the website.

Technical Specifications

Model	CS-810
Illumination mode	d/0 (diffused illumination, 0 degree observer angle), conform to CIE No.15, ISO 7724/1, ASTM E1164, DIN 5033 Teil7, and JIS Z8722 Condition c standards
Size of integrating sphere	Φ40mm, Avian-D diffused reflection surface coating
Illumination Light source	CLEDs (total spectrum LED light source)
Sensor	dual light path sensor array
Wavelength range	400-700nm
Wavelength interval	10nm
Half spectral width	5nm
Transmittance/reflectivity range	0-200%
Spectral resolution	0.0001
Observer angle	2°/10°
Measurement light source	A, C, D50, D55, D65, D75, F1, F2, F3, F4, F5, F6, F7, F8, F9, F10, F11, F12, CWF, U30, DLF, NBF, TL83, TL84
Data displayed	Transmittance Value and Figure, chromatic values, color difference values, pass/fail results, color deviation, color simulation, color simulation history, input standard samples, test results
Test intervals	1second
Test time	1second
Measurement caliber	Φ10mm
Color space	CIE Lab, LCh, CIE Luv, XYZ, Yxy, transmittance, Hunter Lab, Musell, MI, CMYK
Color difference formulas	$\Delta E^*ab, \Delta E^*CH, \Delta E^*uv, \Delta E^*cmc(2:1), \Delta E^*cmc(1:1), \Delta E^*94, \Delta E^*00$
Other color indices	WI(ASTM E313-00, ASTM E313-73, CIE/ISO, Hunter, Taube, Berger Stensby), YI(ASTM D1925, ASTM E313-00, ASTM E313-73), Tint(ASTM E313-00), Milm, color stain, color fastness, APHA, Pt-Co, Gardner, Saybolt, Astm color, Hazen
Repeatability	Transmittance: Standard deviation within 0.08%, Chromaticity value: $\Delta E^*ab: 0.15$ Avg(When a white tile is measured 30 x at 5-second intervals after white calibration), 0.03 Max
Data port	USB
Storing data	Mass storage(PC)
Light source longevity	5 years, 1.5 million tests
Data storage	20000 measurements
Size	475*340*150mm(L*W*H)
Working temperature range	0 C to 45 C, relative humidity 80% or below (at 35°C), no condensation
Storage temperature range	-25 C to 55 C, relative humidity 80% or below (at 35°C), no condensation
Standard accessories	Power cable, color QC software, driver software, USB cables, black calibration tile, glass cell
Optional Accessories	40*33mm glass cell(ASTM Color), 40*100mm glass cell(Saybolt)

Appearance and structure



Instrument Front

- ①. Sample Room: for holding target and samples
- ②. Sample Support Pulling Bar: Pushing the bar will change sample support bar position
- ③. Instrument Brand



Instrument Back

- ①. Power Socket: Instrument Power Socket
- ②. On-off Button: Turn on or turn off the instrument
- ③. USB Output: Connect instrument with PC

Instrument Installation

Part One. Instrument Installation Environment

1. Instrument rated voltage should be 220V,50Hz. Instrument can not work well with unstable voltage.
2. Instrument should be installed in dry environment.
3. Instrument should be fixed on a flat place and no vibration.
4. Instrument should be away from electric field.
5. No direct sunlight to the instrument.
6. Instrument power supply should be with earth wire.

Part Two. Instrument Installation

1. Check if any damage on the instrument after open the case. Then check all accessories according to the packing list.
2. Take the instrument out after all accessories are OK.
3. Check if the instrument is in good condition.

Driver Installation

1. Turn on the driver file, if your PC is 64, double click VCPVCP_V1.3.1_Setup_x64.exe as show in figure

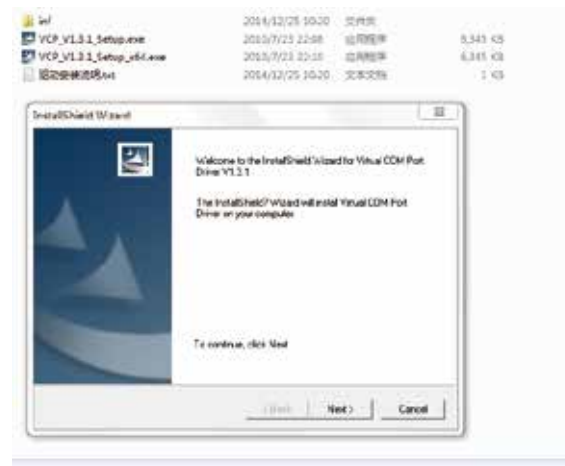

2. Press “next” for installation



3. When you see the below picture, the installation is finished.

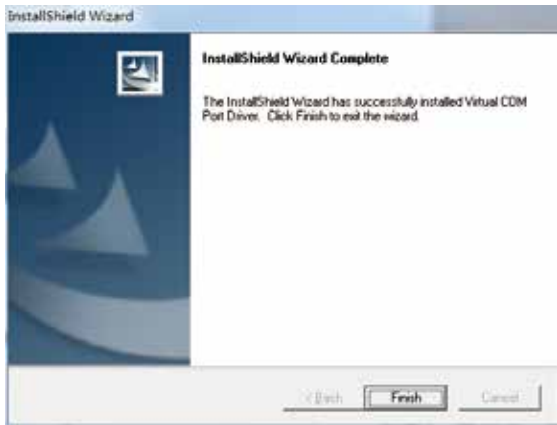

4. If your computer is 32, double click dpinst dpinst_x86.exe . Then install the software according to the above steps.

Instrument Operation

Step 1. When using the instrument, firstly let it warm up for 30 minutes.

Step 2. Connect it with power 220V as show in figure.



Step 3. Turn on the instrument.

Step 4. Black calibration: open the sample room, put the calibration tile into it and then close the cover for calibration.

Step 5. White calibration: Pour distilled water into the glass cell, then put the glass cell into measurement area.

Step 6. Open the software. Measure the target firstly and then the measure the sample.

Step 7. In the software, click “setup” — “list option” — “Spectrum” , “Color space” ,” index”

As show in the figure

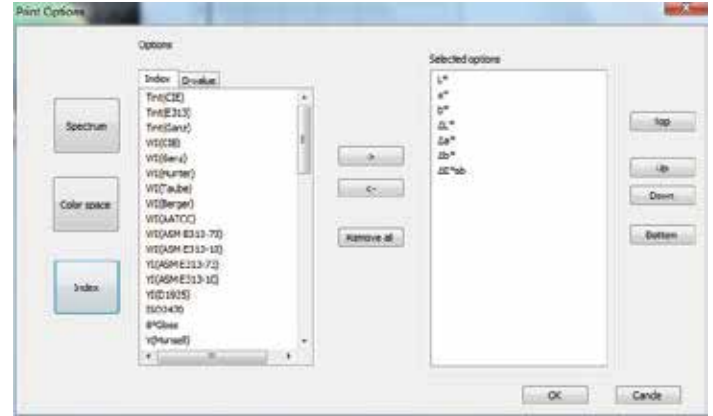
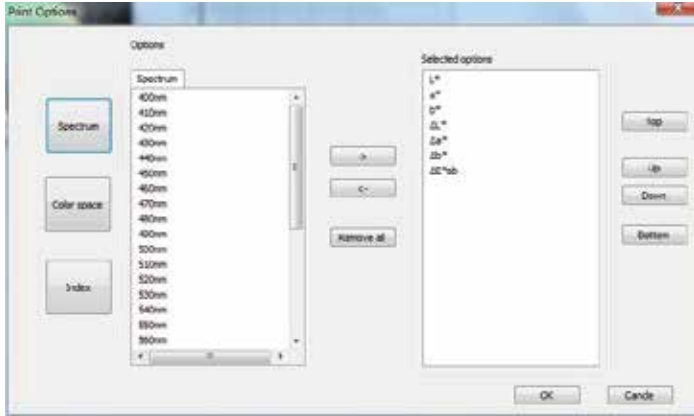

The position could be changed, as show in figure

Num	Name	Test Mode	L*	a*	b*	ΔE*ab	400nm	410nm

Num	Name	Test Mode	L*	a*	b*	400nm	ΔE*ab	410nm

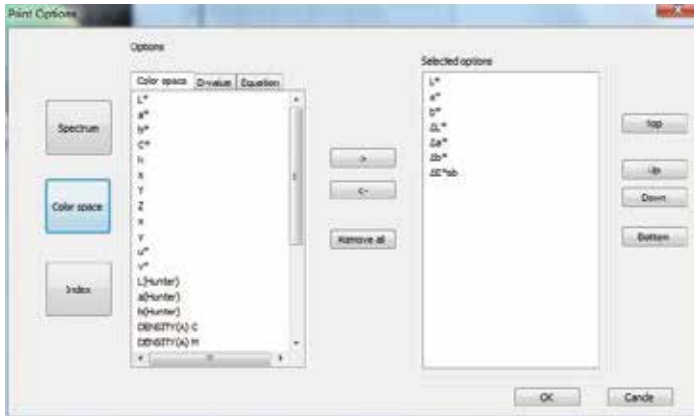

The selected option position could also be changed by pressing "up" or "down".

Testing

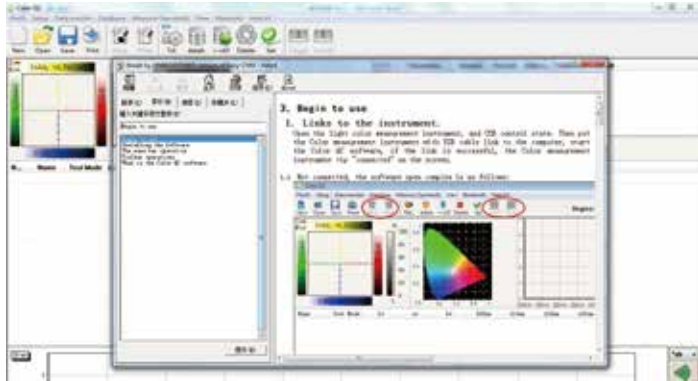

Turn on color QC software, click “help” and “content” . We could see the software operating manual as show in figure.

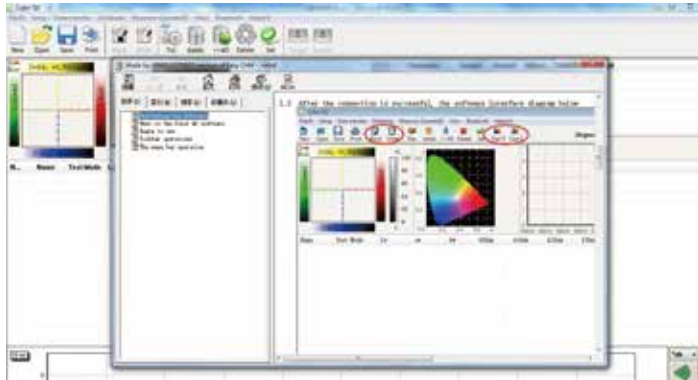

In the left column, we could see the catalogue of the operating manual. When instrument is not connected with PC, black/white calibration and target / sample button is grey.

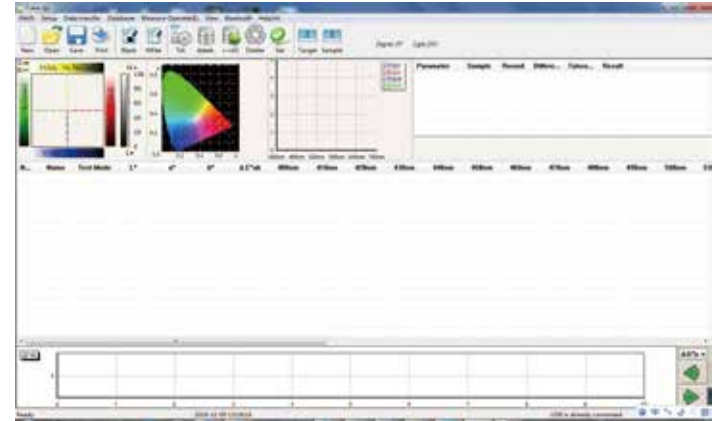

When instrument is connected with computer, black/white calibration and target / sample button can be clicked.

Calibration

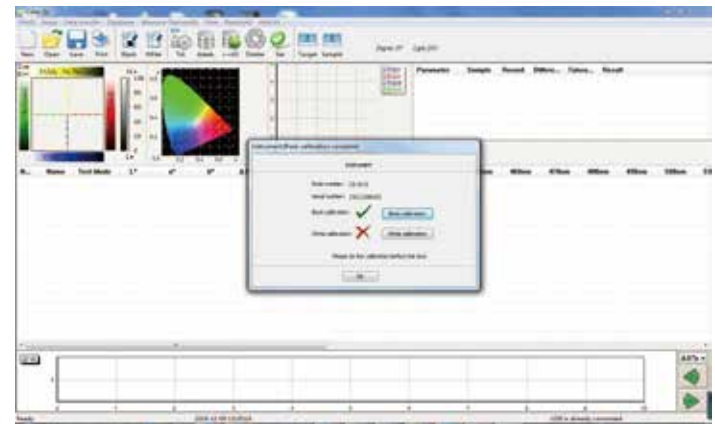

When instrument is connected with computer, put the black calibration tile into the instrument, close the cover, click “Black” for calibration.

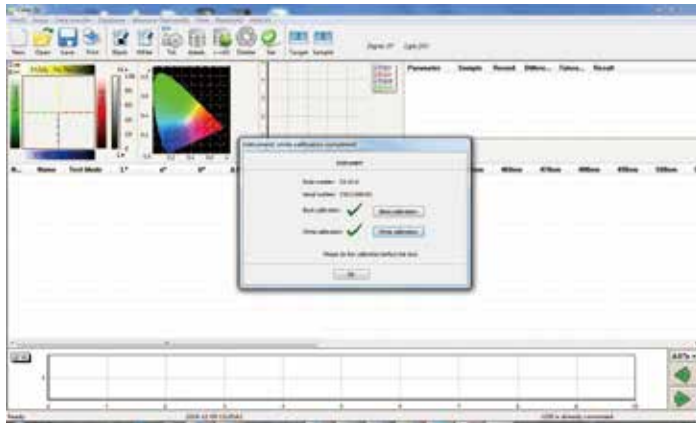

After black calibration, take the tile out, put the glass cell with distilled water glass cell support, then press white calibration on the pop-up menus for white calibration.

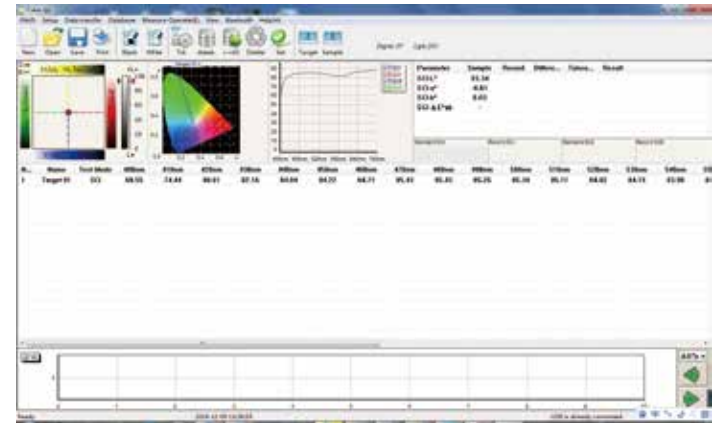

After white calibration, put the target on the cuvette support. Click "target" for measurement (as show in the figure).

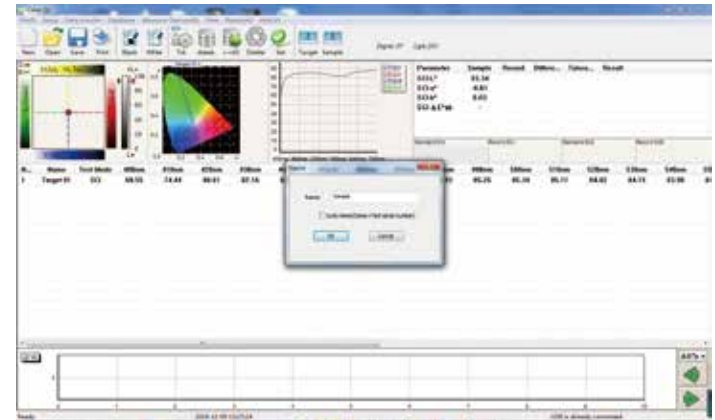

After measurement, save and name the sample (as show in figure).

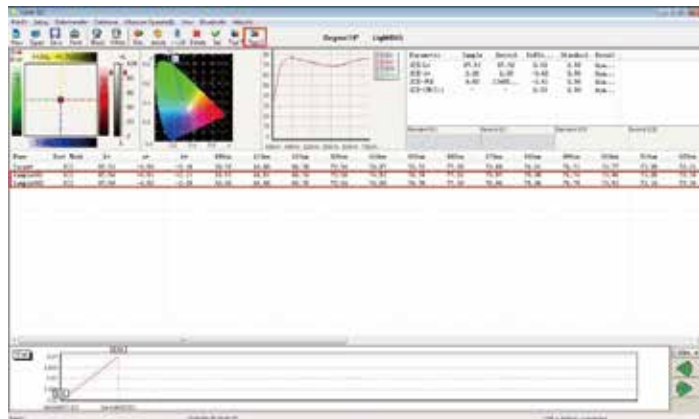

After target measurement is finished, put sample on the cuvette support. Click "sample" for measurement, we will get the testing result. We could compare and print the testing result.

System deployment diagram

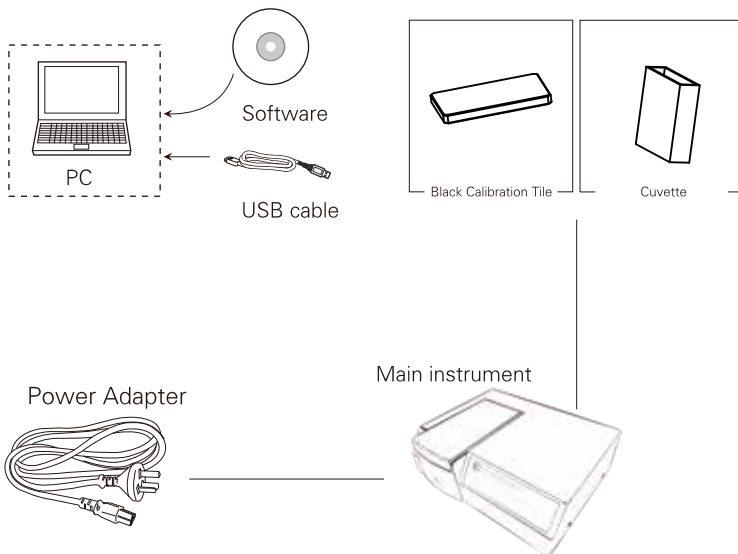

Trouble Shooting

Error	Analysis	Handling
1. Unable to switch on	1. Check battery or power cable	Install connect power cable to power source
2. Exception in measurement results	Check if the tolerance setting is reasonable	Check and change tolerance settings
3. Unreasonable measurement results	1. Check if the instrument is lying stably on a flat sample 2. Check if the sample is too thin 3. Check if there are multiple colors in the test area	1. Make sure instrument is lying flat 2. Put a thick piece of white paper under sample 3. Only check single color

Testing Result Analysis

▼ ΔE Color Difference Scale $\Delta E^*ab = \sqrt{(\Delta L^*)^2 + (\Delta a^*)^2 + (\Delta b^*)^2}$

$\Delta L+$ represents white, $\Delta L-$ represents black, $\Delta a+$ represents red, $\Delta a-$ represents green, $\Delta b+$ represents yellow, $\Delta b-$ represents blue. When we use CIE $L^*a^*b^*$ to show a color, L^* is black or white. a^* is red or green. b^* is yellow or green.

▼ CIE LAB

CIE LAB is color space based on the fact that a color can't be both red and green, or both blue and yellow, because these colors oppose each other. So a single data could be used to describe red/green and yellow/blue. When we use CIE $L^*a^*b^*$ to describe a color, L^* means lightness, a^* means red/green and b^* means yellow/blue.

▼ CIE LCH

CIE LCH adopts same color space as $L^*a^*b^*$, but its L^* represents lightness, c^* represents saturation and h^* represents hue.

Company's statement

- 1.The company promises that our spectrophotometer offers one year of warranty from the purchase date. Non-artificial damage under normal use is subjected to free warranty. The company offers repair services for artificial damage, or damage after the warranty period ; however, the repair services would require fees relative to the damage.
- 2.The warranty only holds for the person, or company who purchased the instrument. Damage occurred by the third party usage would not be eligible for warranty service.
- 3.The company is not responsible for data loss because of error, repairing, or power outages. To prevent loss of important data, please save copies of the data on your PC.
- 4.The copyright ownership of the instrument and its associated software belong to CHNSpec and is protected by the Copyright Laws of People's Republic of China.
- 5.Our company sells the instrument does not mean we transfer the copyright, or any intellectual property's ownership to the user.
- 6.The specifications and information in this manual are subjected to further updates without notice.