



快速使用教程

1. 开机及校准



开机

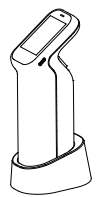

将仪器放到校准底座进行白校准



将仪器对准空气进行黑校准

2. 如何测色差

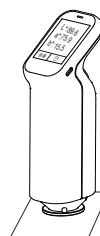

测标准

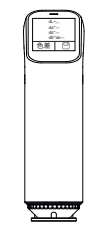

切换到色差测量界面

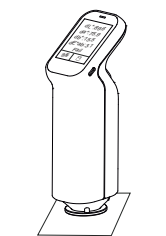

测样品, 得出色差

3. 关机



长按3秒

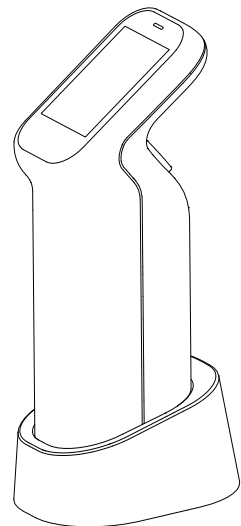

分光色差仪CS-410 使用说明书

产品介绍

使用产品前请仔细阅读本说明书, 并妥善保管

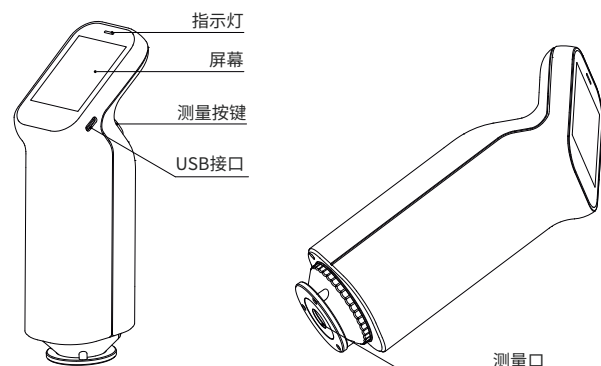

主机

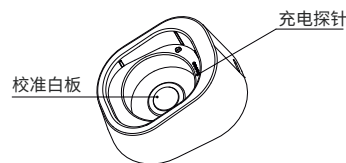

校准充电底座

基础参数

产品型号: CS-410
测量结构: D/8,SCI/SCE(漫射照明/8°方向接收,包含镜面反射/去除镜面反射)
符合标准: 符合标准CIE No.15,GB/T 3978,GB 2893
GB/T 18833,ISO7724-1,ASTM E1164,DIN5033 Teil7

分光方式: 集成光学器件
感 应 器: CMOS感应器
测量指标: 光谱反射率

CIE-Lab,CIE-LCh,HunterLab,CIE-Luv,XYZ,Yxy,RGB
色差($\Delta E^*ab, \Delta E^*cmc, \Delta E^*94, \Delta E^*00$)
白度(ASTM E313-00,ASTM E313-73,CIE/ISO AATCC,Hunter,TaubeBerger,Stensby,R457)
黄度(ASTM D1925,ASTM E313-00,ASTM E313-73)
黑度(My,dM),沾色牢度,变色牢度,Tint(ASTM E313-00)
色密度CMYK(A,T,E,M),同色异谱指数MilM
孟塞尔,遮盖力,水份(染料强度,着色力)

积分球直径: 40mm
照明光源: LED(全波段均衡LED光源)
测量/照明口径: $\phi 8mm/\phi 11mm$
波长间隔: 10nm
波长范围: 400-700nm
反射率测定范围: 0-200%
反射率分辨率: 0.01%
测量精度: 0.01
测量稳定性: 色度值: 标准偏差 $\Delta E^*ab \leq 0.04$
平均值 $\Delta E^*ab \leq 0.05$; 最大值 $\Delta E^*ab \leq 0.08$
(白板校准后以5秒间隔测量白板30次)

台 间 差: $\Delta E^*ab \leq 0.4$ (BCRA II 系列12块色砖测量平均值)
测量时间: 约1秒
接 口: USB
光源条件: A,B,C,D50,D55,D65,D75,F1,F2,F3,F4,F5,F6,F7,F8,F9,F10
F11,F12,CWF,U30,U35,DLF,NBF,TL83,TL84

视 场 角: $2^\circ, 10^\circ$
屏 幕: IPS全彩屏幕,2.4英寸
电池容量: 单次充电可连续测量8000次,3.7V/3000mAh
光源寿命: 10年100万次
语 言: 简体中文,英语
校 准: 自动校准
软件支持: Windows
摄像头取景定位: 无
重 量: 约280g
体 积: 180mm*60mm*51mm
是否能过计量: 可过计量
存 储: 100条数据

*参数如有修改, 恕不另行通知

保修说明

本产品售后服务严格依据《中华人民共和国消费者权益保护法》、《中华人民共和国产品质量法》实行售后三包服务, 服务内容如下:

- 1、自您签收日起7日内, 本产品出现《产品性能故障表》所列性能故障的情况, 经由本司售后服务中心检测确定, 可免费享受退货或换货服务;
- 2、自您签收日起8-15日内, 本产品出现《产品性能故障表》所列性能故障的情况, 经由本司售后服务中心检测确定, 可免费享受换货或维修服务;
- 3、自您签收日起36个月内, 本产品出现《产品性能故障表》所列性能故障的情况, 经由本司售后服务中心检测确定, 可免费享受维修服务。

提示信息

因运输过程中需用包装箱保证产品运输安全, 建议自签收日起至少保留包装箱30天。

非保修条例

- 1、未经授权的维修、误用、碰撞、疏忽、滥用、进液、事故、改动、使用非本产品配件, 或撕毁涂改标签、防伪标记;
- 2、已超过三包有效期;
- 3、因不可抗力造成的破坏;
- 4、不符合《产品性能故障表》所列性能故障的情况;
- 5、因人为原因导致非本产品及其配件产生《产品性能故障表》所列性能故障。

联系方式

制 造 商: 杭州彩谱科技有限公司
制造商地址: 浙江省杭州市江干区文渊北路166号
客服热线: 4007-7272-81
官方网址: www.hzcaipu.com

警告

- 请勿尝试拆卸或更换仪器内部零件, 如需服务请联系代理商或官方客服。
- 请勿将仪器放置于热源或直接暴露在炉火旁。
- 若任何液体不小心进入仪器, 请立即关闭仪器电源。
- 本产品及内部零件, 如被儿童误食可能导致窒息等危险。

性能故障表

名称	性能故障
分光色差仪 CS-410	1、电源指示灯不亮(电池没电除外); 2、仪器开关卡滞,不能正常开关; 3、仪器显示器无法正常显示; 4、测量光源不亮; 5、蓝牙无法连接。

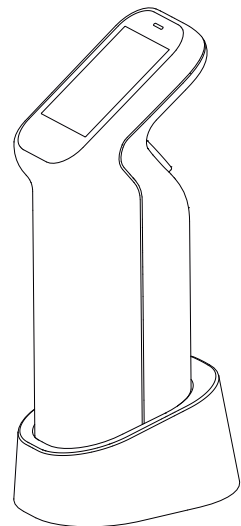

Spectral Colorimeter CS-410 Operation Instruction

Product introduction

Please read this manual carefully before using the product.

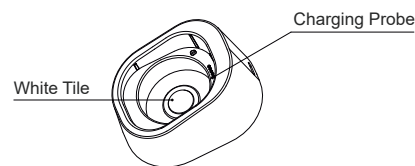
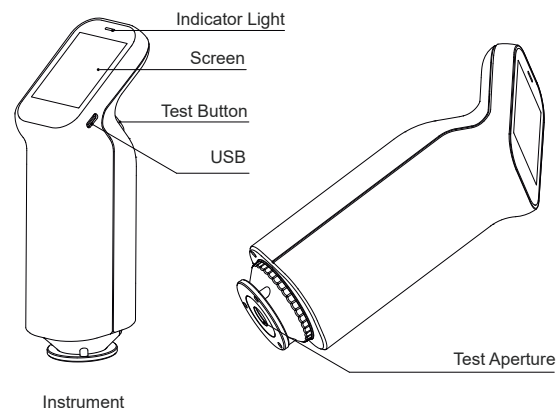

Calibration and Charging Base

Quick Start

1. Power on Calibration



Power on

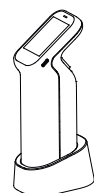

Place the instrument on the calibration base for white calibration.

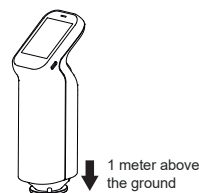

Measure air for black calibration

2. How to measure color difference

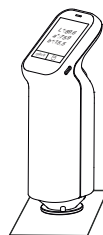

Measure Target

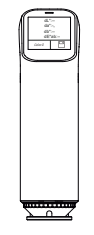

Enter into color difference measurement interface

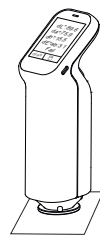

Measure sample to get the color difference

3. Power off

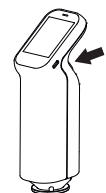

Long press 3s

Parameters

Product Name:	CS-410
GeoMetry and Angle:	d/8 (diffused illumination, 8 degree viewing) SCI (specular component included) +SCE (specular component excluded)
Standards compliant:	Conform to standard CIE No.15, GB/T 3978, GB 2 GB/T 18833, ISO7724-1, ASTM E1164, DIN5033 Teil7
Spectroscopic method:	Integrated Optical Component
Sensor:	CMOS sensor
Color Value:	Reflectance CIE-Lab, CIE-LCh, HunterLab, CIE-Luv, XYZ, Yxy, RGB ColorDifference ($\Delta E^*ab, \Delta E^*cmc, \Delta E^*94, \Delta E^*00$) WI (ASTM E313-00, ASTM E313-73, CIE/ISO AATCC, Hunter, TaubeBerger, Stensby, R457), YI (ASTM D1925 ASTM E313-00, ASTM E313-73), Blackness (My, dM), Color Fastness Tint (ASTM E313-00), Color Density (CMYK(A, T, E, M)), Milm Munsell, Opacity, ColorStrength
Integrating sphere diameter:	40mm
Lighting source:	LED (Full band balanced LED light source)
Measurement Area/ Aperture Size:	$\Phi 8\text{mm}/\Phi 11\text{mm}$
Wavelength Interval:	10nm
Wavelength Range:	400-700nm
Reflectance measurement range:	200%
Reflectance resolution:	0.01%
Measurement accuracy:	0.01
Repeatability:	Chromaticity value: Standard deviation $\Delta E^*ab \leq 0.04$ Average: $\Delta E^*ab \leq 0.05$; Max: $\Delta E^*ab \leq 0.08$ (when a white tile is measured 30 times at 5-seconds interval)
Inter-instrument agreement:	MAV/SCI, $\Delta E^*ab \leq 0.4$ (BCRA Series II, average measurement of 12 tiles)
Measurement Time:	About 1S
Interface:	USB
Illuminants:	A, B, C, D50, D55, D65, D75, F1, F2, F3, F4, F5, F6 F7, F8, F9, F10, F11, F12, CWF, U30, U35, DLF, NBF, TL83, TL84
Observer Angle:	2°, 10°
Screen:	IPS full color screen, 2.4 inches
Battery:	Rechargeable, 8,000 times continuous tests, 3.7V / 3000mAh
Light Source Lifetime:	10 years, 3 million tests
Language:	Chinese, English
Calibration:	Automatic
Software support:	Windows
Camera:	no
Weight:	About 280g
Instrument Size:	180mm*60mm*51mm
Pass Metrology:	Yes
Storage:	100 values

*Parameters are subject to change without notice

Warranty

Reminder

It is recommend that keep the packing box for at least 30 days as the packing box is required to ensure the safety of transportation.

Non warranty regulations

1. Unauthorized repair, misuse, accident, modification, use of nonofficial accessories.
2. Instrument is out of warranty.
3. Damage caused by force.
4. Not the performance failure listed in the product performance failure table.
5. Performance failure caused by human factors.

Contact

Manufacturer: Hangzhou CHNSpec Technology Co., Ltd
Address: No.166, Wenyuan North Road, Jianggan District
Hangzhou, China
Tel: +86 571 85888707
Website: www.chnspec.com

Warning

- . Do not attempt to disassemble or replace any part of the equipment. Please contact the agent or official customer service for after sales service.
- . Do not place the equipment near heat source or directly expose to the fire.
- . If any liquid enters the equipment, please power off the equipment immediately.
- . This product contains small parts. It may cause suffocation and other hazards, if swallowed by children.

Product Performance Failure Table

Name	Performance failure
Spectral Colorimeter CS-410	<ol style="list-style-type: none"> 1. The equipment can't power on. 2. The equipment's button can't work normally. 3. Equipment screen fails to work normally. 4. Equipment lamp fails to work normally. 5. Bluetooth can't connect.