

V.20250710\_07

## Haze meter

Product Instructions ►

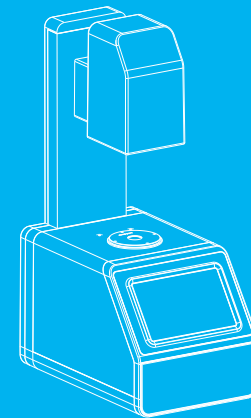

---

# CATALOGUE

---

[I] Instructions for use .....	01
[II] Precautions .....	01
[III] Functional description .....	02
[IV] Technical parameters .....	02
[V] Appearance structure introduction .....	03
[VI] Measurement flow chart .....	04
[VII] Program interface introduction .....	04
[VIII] Measurement .....	05
[IX] Calibration .....	06
[X] Data viewing .....	07
[XI] Settings .....	08
[XII] Measurement settings .....	08
[XIII] System settings .....	12
[XIV] Parameter introduction .....	14
[XV] Abnormal analysis and processing .....	14
[XVI] Attachments .....	14
[XVII] Company statement .....	15

## Instructions for use

1. The haze meter is an instrument designed to measure the haze and total light transmittance of transparent and translucent parallel plane materials such as plastics, films, glass products, LCD panels, etc.
2. The haze meter is widely used in laboratories, factories or field operations, and is sufficient to achieve the best haze measurement in quality control in almost all application fields.
3. The limited warranty period is from the purchase of this instrument (time: such as one year). If your instrument needs service, please bring the instrument to the local sales department to contact us for repair.
4. In order to avoid affecting the accuracy of the instrument, please do not disassemble the instrument privately. If the instrument is damaged due to private disassembly of the machine or improper use, please be responsible for it.

## Precautions

1. This machine is a precision instrument and cannot withstand collisions caused by falling. Please place it in a relatively flat place when using it.
2. This machine is not moisture-proof or moisture-resistant. It is easy to be damaged by moisture or liquid splashing.
3. The screen of this machine is made of glass and is easily damaged by abnormal external force or sharp objects.
4. The company recommends using the original power adapter.
5. To ensure the normal operation of this machine, please do not store and use it in too cold or too hot places, and do not place this machine in a humid or long-term direct sunlight place, let alone use this machine in harsh environments such as strong earthquakes to avoid accidents.
6. This machine is a precision instrument. Please avoid strong electromagnetic interference when using it.
7. To ensure accurate measurement, please keep the instrument stable during testing and do not shake it.
8. This machine is a precision instrument. Please turn off the instrument for safekeeping after use.
9. Please store the instrument in a dry place.
10. It is forbidden to clean the inside of the integrating sphere.
11. If the instrument fails, please do not try to repair it yourself. Our customer service department will provide assistance to customers quickly.
12. If there are further improvements or additions to this machine and the manual, we will not notify you separately. If you have any questions, please contact our company.

## Functional Description

1. The haze meter complies with the following test standards: ASTM D1003/D1044, ISO 13468/ISO 14782, JIS K 7105, JIS K 7361, JIS K 7136, GB/T 2410-2008.
2. The haze meter meets the haze and total transmittance measurement under three standard lighting sources: CIE-A, CIE-C, and CIE-D65.
3. The haze meter meets the compensation method test and can provide more accurate test results.
4. The haze meter has an open measurement area that can meet the measurement of samples of any size.
5. The haze meter has a 7-inch IPS full-viewing angle LCD screen with a good human-computer interaction interface.
6. The haze meter provides professional haze and transmittance measurement and analysis software to meet the user's analysis and management of test data.

## Technical Parameters

Light source	CIE-A, CIE-C, CIE-D65
Standard	ASTM D1003/D1044, ISO13468/ISO14782, JIS K 7105, JIS K 7361, JIS K 7136, GB/T 2410-08
Measurement parameters	Haze and transmittance under ASTM and ISO standards
Spectral response	CIE spectral function Y/V( $\lambda$ )
Geometry	0/d
Measurement aperture	21mm, 7mm
Range	0-100%
Resolution	0.01%
Repeatability	0.05
Sample size	Thickness $\leq$ 145mm
Display	7-inch TFT touch screen
Storage data	20,000 values
Interface	USB interface
Power supply	DC 12V/3A
Working temperature	5~40 C , relative humidity 80% or less (at 35 C), no condensation
Storage temperature	-20~45 C , relative humidity 80% or less (at 35 C), no condensation
Dimension	Length x width x height: 310mmX215mmX540mm
Weight	6kg
Standard	PC management software (HAZE QC)
Optional	Measuring fixture, haze standard sheet, custom aperture plate

## Appearance and structure introduction

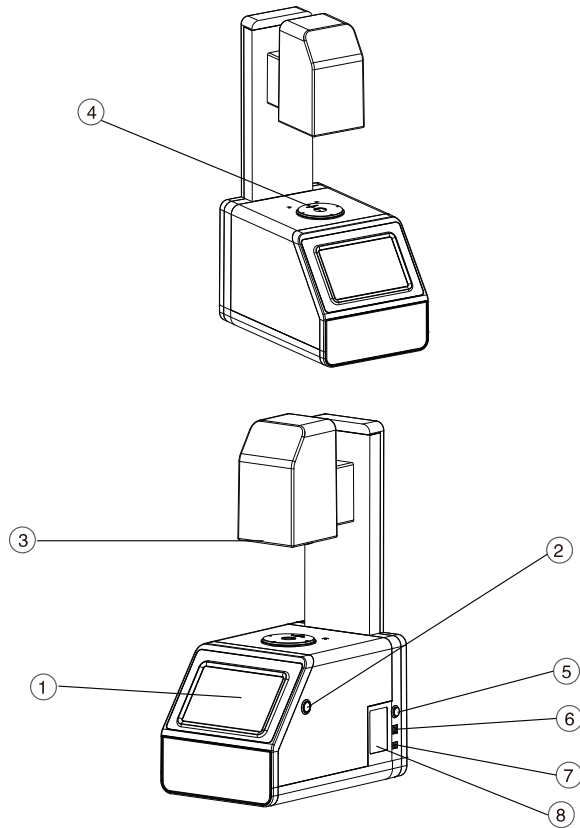

- |                  |                |
|------------------|----------------|
| ① Display screen | ⑤ Power switch |
| ② Test button    | ⑥ USB port     |
| ③ Light outlet   | ⑦ Power port   |
| ④ Test port      | ⑧ Nameplate    |

## Measurement flow chart

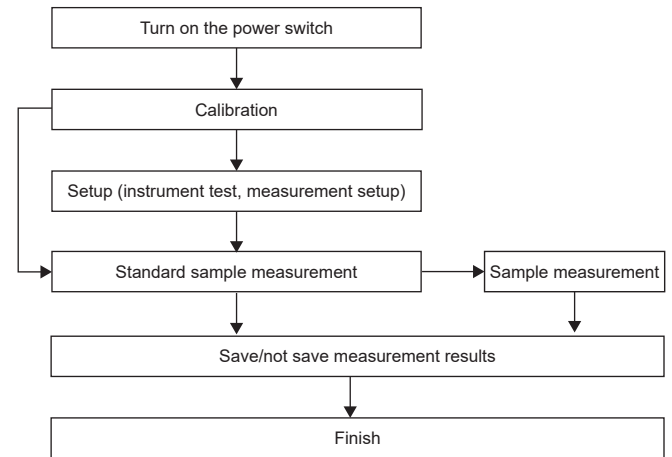

## Program interface introduction



A-1

## A-1

Basic operation method of the instrument: Capacitive touch screen, click to select the corresponding functional module.

Measurement: Users can measure the total transmittance and haze parameters of the sample, measure the difference between the sample and the standard sample, and save the test records.

Calibration: On this page, users can calibrate the instrument.

Data browsing: On this page, users can view the various parameters under the saved standard sample, and can view the sample, call out to measurement, delete and edit the name of the selected standard sample.

Setting: Users can select and set various parameters of the instrument measurement conditions.

## Measurement

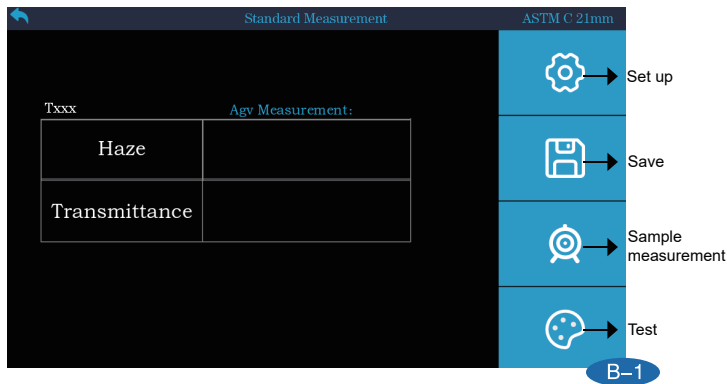

## B-1

### Standard sample measurement

After placing the standard, click the "Test" button on the screen or press the "Enter" key of the machine. After a "beep", the measurement is completed and the measurement results are checked. The title bar of the test result shows the test standard and parameters. When the standard is not saved, the standard name is always displayed as "Txxx". When the "Save" button is pressed to save the standard, the name is displayed as the standard name after saving. The test standard and parameters can be set in the "Measurement Settings" before measurement (refer to the description of the setting section)

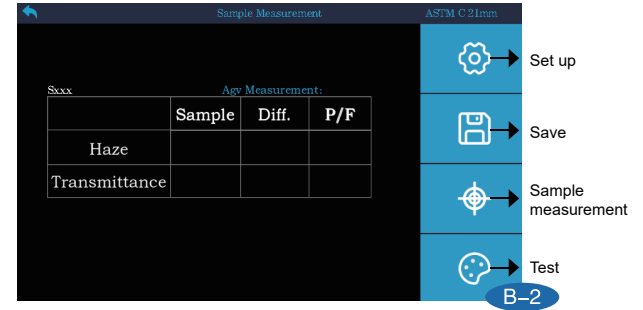

## B-2

### Sample measurement

After the standard sample measurement is completed and saved, click the Measure Sample button to enter the "Sample Measurement" interface under the standard sample, click the "Test" button on the screen or press the "Enter" key to measure, and the sample measurement is completed after the "beep" sound, and the measurement results can be viewed. Press the "Test" key again to measure a new sample. Similar to the standard sample measurement, when the sample measurement is not saved, the sample name is displayed as "Sxxx", and after saving, it is displayed as the saved name. Note: Please set the tolerance before measuring the sample. (View tolerance settings)

## Calibration

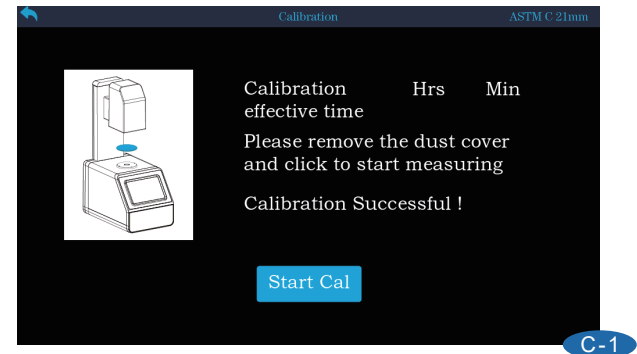

According to the prompts on the instrument interface, keep the test port facing the air and click the "Start Calibration" button to perform the calibration operation.

## Data View

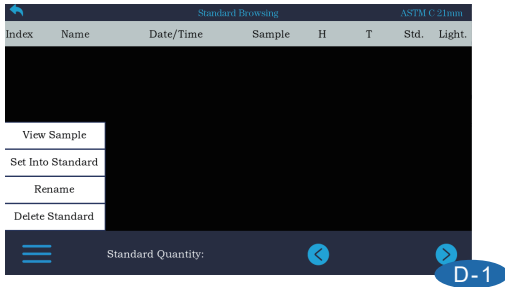

D-1

In the standard sample data browsing interface, you can see the saved standard sample data and parameters. You can do the following processing on the standard sample data:

**View sample:** View the sample data under the selected standard sample.

**Call out to measurement:** You can call out the selected standard sample to the measurement interface.

**Rename:** You can rename the selected standard sample.

**Delete standard sample:** You can delete the selected standard sample.

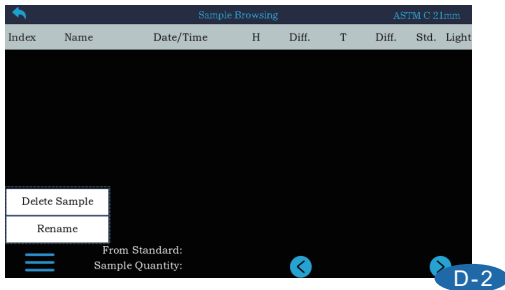

D-2

After selecting the standard sample in the standard sample data browsing interface, click the View Sample button to enter the sample data browsing interface, where you can see the saved sample data and parameters. You can do the following processing on the sample data:

**Delete standard sample:** You can delete the selected sample.

**Rename:** You can rename the selected sample.

## Set up

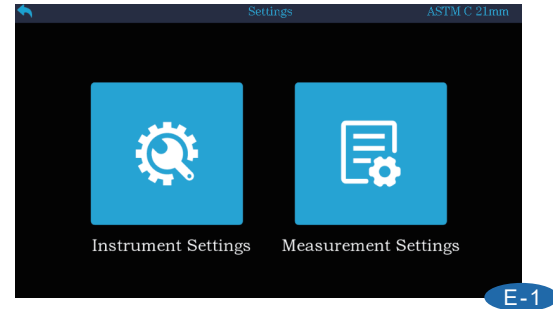

E-1

**Instrument Settings:** On this page, you can set the instrument's backlight, time, and language, view the instrument's version number, and restore factory settings.

**Measurement Settings:** On this page, you can set the instrument's measurement standard, light source, tolerance, measurement mode, calibration time, aperture, whether to average measurement, and whether to automatically save.

## Measurement setup

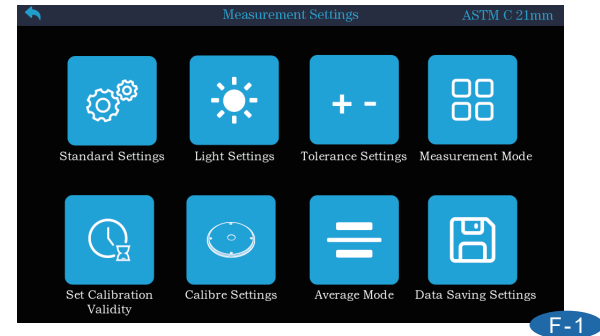

F-1

**Measurement settings:** Touch to select standard, light source, tolerance, measurement, calibration time, aperture, average measurement, and saved settings.

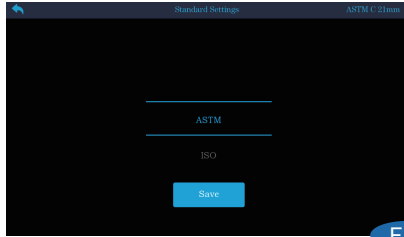

F-2

F-2

Standard setting: You can set the measurement standard of the instrument and choose between ASTM and ISO.

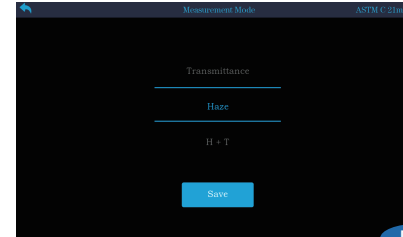

F-5

F-5

Measuring mode: You can set the display parameters of the instrument.

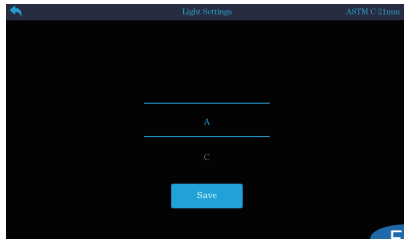

F-3

F-3

Light source setting: You can choose to set it from three light source conditions: CIE-A, CIE-C, and CIE-D65.

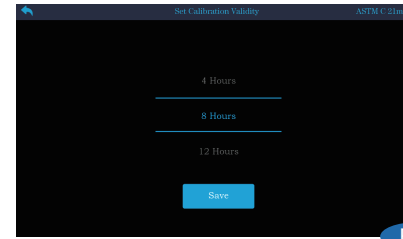

F-6

F-6

Calibration time: You can set the effective time of calibration. After the calibration time is exceeded, recalibration will be required.

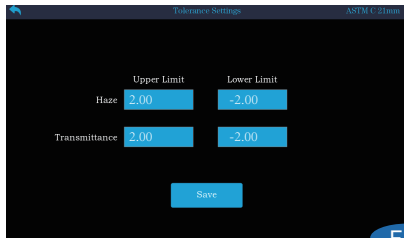

F-4

F-4

Tolerance setting: You can set the upper and lower tolerances of the instrument. Under the sample interface test, if the tolerance is exceeded, it will be displayed as unqualified.

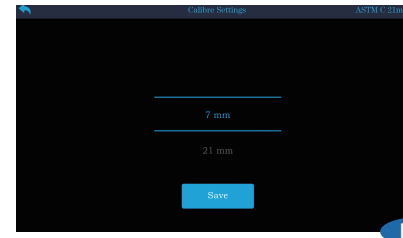

F-7

F-7

Caliber setting: The caliber can be switched, but the actual caliber of the instrument needs to be changed manually.

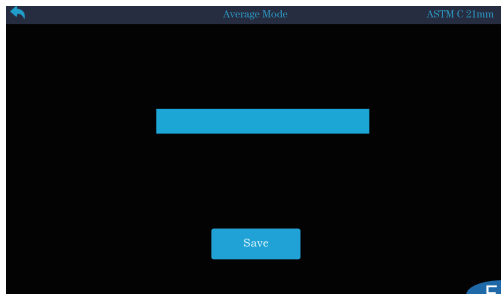

F-8

F-8

Average setting: You can set the average number of times for each measurement.

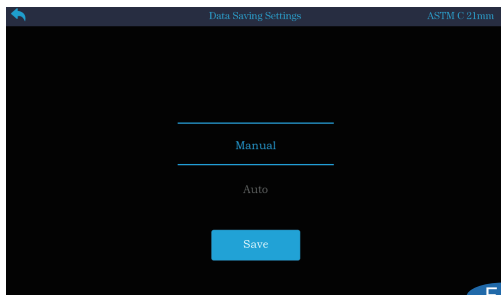

F-9

F-9

Save settings: You can choose to save in "manual save" or "automatic save".

## System Settings

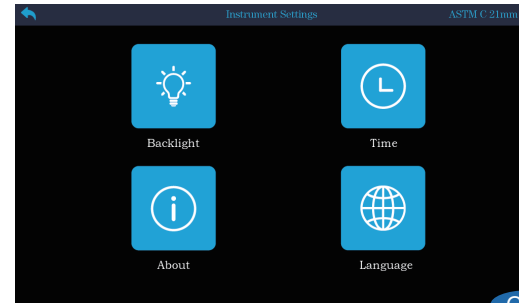

G-1

G-1

System settings: You can touch the screen to set backlight, time, about, and language.

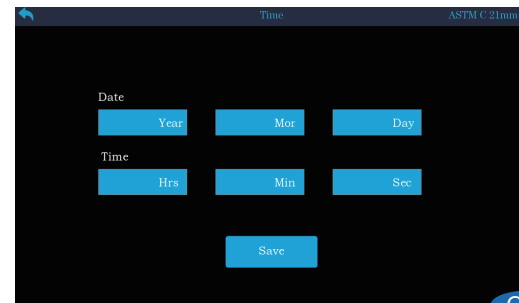

G-2

G-2

Time setting: You can set the current time of the instrument.

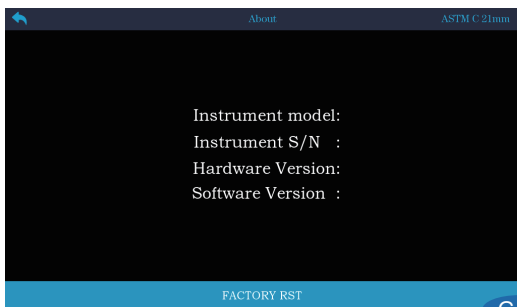

G-3

G-3

About: This interface can display the version number of the instrument and can also be used to restore factory settings.

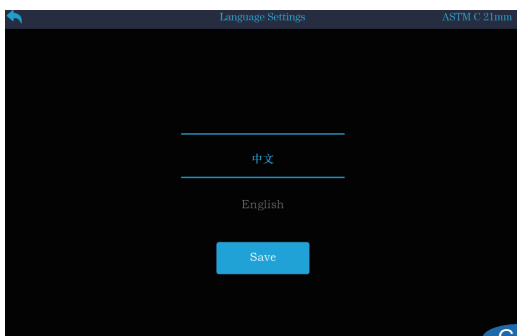

G-4

G-4

Language setting: You can set the display language of the instrument. This instrument provides two interface languages: Chinese and English.

## Parameter Introduction

### Haze

Diffuse scattering will reduce the imaging quality of the object. Small particles inside the material or the surface of the sample will cause scattering. The scattered light will scatter to different angles and the light density at each angle is very small, which will lead to a reduction in contrast and the sample will form a milky or cloudy appearance. This phenomenon is called haze. According to the ASTM D1003 standard, haze is the percentage of the total transmitted light where the transmitted light is scattered beyond 2.5°.

### Transparency Assessment Criteria

The appearance of transparent products has characteristics such as gloss, color and transparency. Transparency is particularly important and its evaluation conditions are: transmittance, haze, etc. Transmittance is the ratio of all transmitted light to incident light. It decreases as the material surface reflects and absorbs light.

## Trouble Shooting

Abnormal situations	Analyze	Solution
1. The instrument cannot be turned on	The power connection may be abnormal	Check whether the power interface is in good contact and plug in the power cord.
2. Unable to enter the main program after booting	The power-on calibration process may be abnormal	Re-calibrate as required to ensure successful calibration
3. Measurement result error	The tolerance setting may be abnormal	Check tolerance settings and adjust
4. Abnormal test values	<ol style="list-style-type: none"> <li>Whether the sample fits tightly to the measuring port</li> <li>Whether the sample surface is severely damaged</li> </ol>	<ol style="list-style-type: none"> <li>Check the fit between the sample and the measuring port to ensure a tight fit</li> <li>Check the surface of the sample to ensure that the sample is intact and has no effect on the measurement</li> </ol>

## Accessories

### Standard accessories

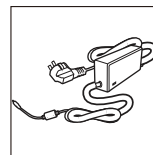

External power adapter

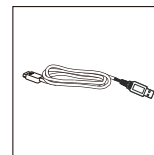

USB data cable

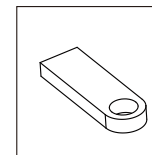

Data management software USB flash drive

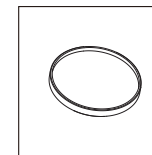

Dust cover

## Optional accessories

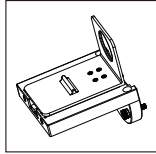

Cuvette holder

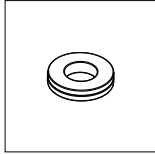

Film holder

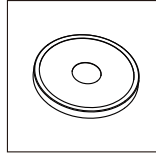

Haze standard plate

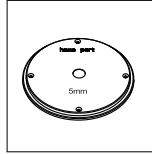

5mm diameter plate

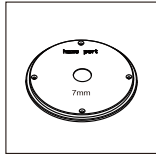

7mm diameter plate

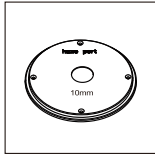

10mm diameter plate

## Company Statement

- Our company promises to users that the warranty period of the fog meter we produce is valid for three years from the date of purchase. Under normal use, if the fault is not caused by human factors, our company will be responsible for free repair. If the fault exceeds the warranty period or is caused by human factors, our company will provide maintenance, but will charge for repair materials and related fees.
- The company is not responsible for any losses or claims caused by third parties due to the use of this product.
- The Company is not responsible for any damage or loss caused by data loss due to malfunction, maintenance or power outage. To prevent the loss of important data, please be sure to back up all important data.
- The copyright of all works pre-installed in this product belongs to our company and is protected by the Copyright Law of the People's Republic of China.
- Our company's sale of this product does not represent the transfer or granting of any rights related to the copyright of the work to the user.
- The product specifications and information mentioned in this manual are for reference only and the content may be updated at any time without prior notice.